



INTAKE SYSTEMS FOR VEHICLES LISTED ARE 50 STATE LEGAL. SEE KNFILTERS.COM FOR CARB STATUS ON EACH PART FOR A SPECIFIC VEHICLE.

INSTALLATION INSTRUCTIONS

57-1125P

HARLEY DAVIDSON

SEE CATALOG OR KNFILTERS.COM FOR CURRENT APPLICATIONS

TOOLS NEEDED:

- Ratchet
- Extension
- 7/16" Socket
- 3-16" Allen Wrench
- 5/16" Allen Wrench
- T27 Torx Socket

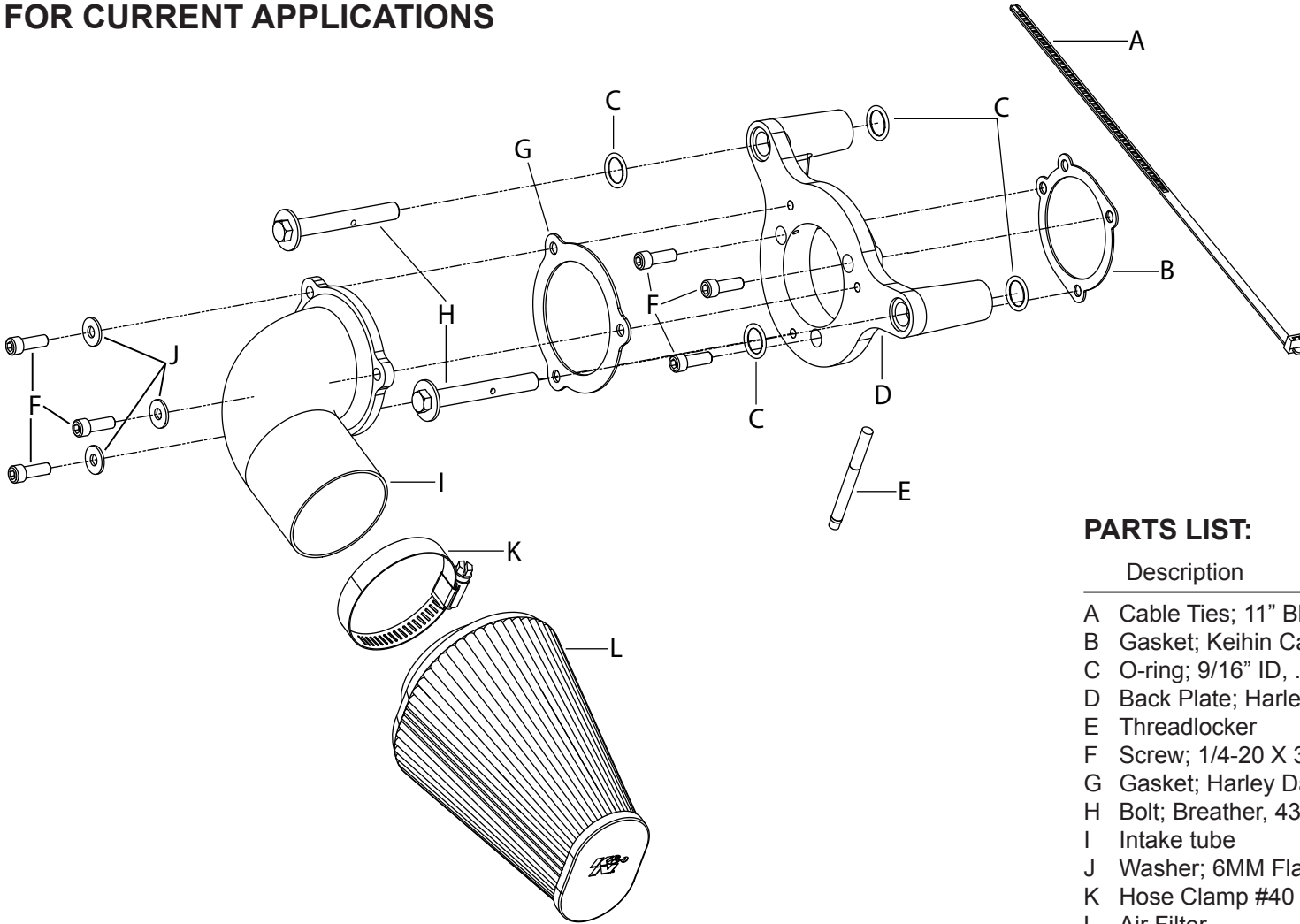

PARTS LIST:

Description	Qty.	Part #
A Cable Ties; 11" Black	1	21590
B Gasket; Keihin Carb.	1	09267
C O-ring; 9/16" ID, .10 Thick	4	07761
D Back Plate; Harley Davidson	1	01907
E Threadlocker	1	482
F Screw; 1/4-20 X 3/4 SOC.	6	07731
G Gasket; Harley Davidson	1	09708
H Bolt; Breather, 4340	2	22212
I Intake tube	1	27459
J Washer; 6MM Flat, SS	3	08269
K Hose Clamp #40	1	08554K
L Air Filter	1	RC-3680

NOTE: FAILURE TO FOLLOW INSTALLATION INSTRUCTIONS AND NOT USING THE PROVIDED HARDWARE MAY DAMAGE THE INTAKE TUBE, THROTTLE BODY AND ENGINE.

TO START:

1. Turn off the ignition and disconnect the negative battery cable.

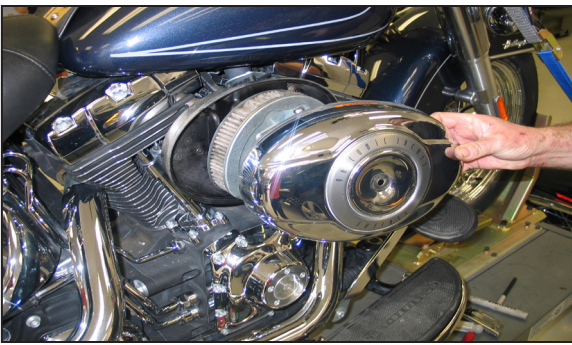

2. Remove the air filter cover retaining bolt and then remove the air filter cover as shown.

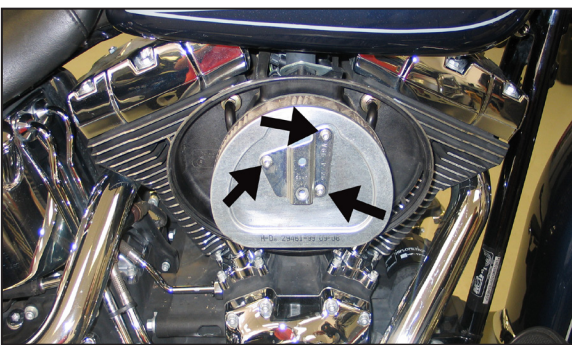

3. Remove the three air filter retaining bolts shown.



4. Remove the air filter with the breather hoses as shown.

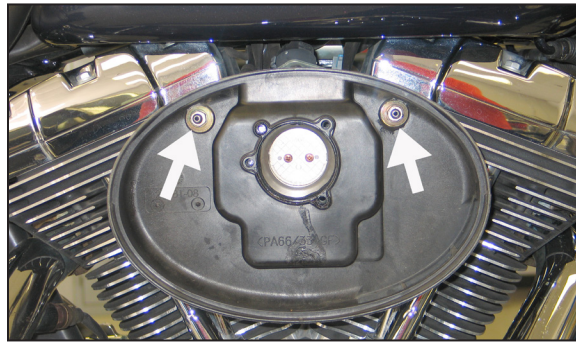

5. Remove the two crankcase breather bolts shown.



6. Remove the air filter breather base as shown. **NOTE: K&N Engineering, Inc. recommends that customers do not discard the factory air intake components.**

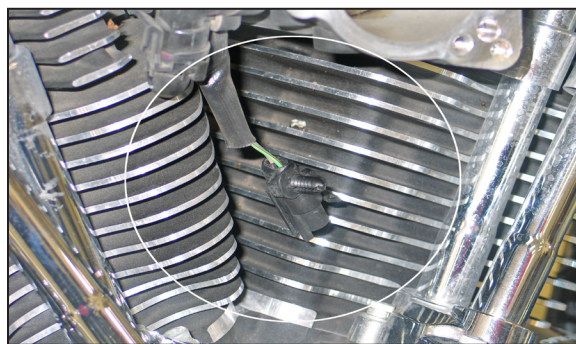

7. Using the provided tie wrap, secure the loose pig tail to the throttle position switch wiring harness.

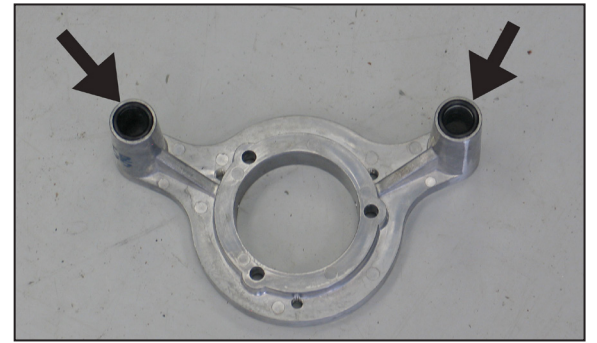

8. Install two of the o rings provided onto the back side of the K&N® back plate as shown.



9. Install the remaining two provided o rings onto the front of the back plate as shown.

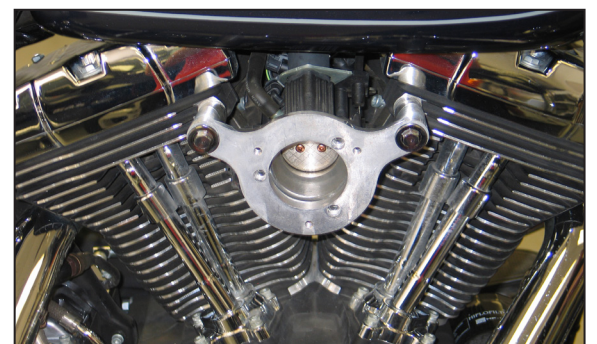

10. Using the two provided crankcase breather bolts; install the back plate onto the vehicle as shown. Do not tighten the breather bolts at this time.

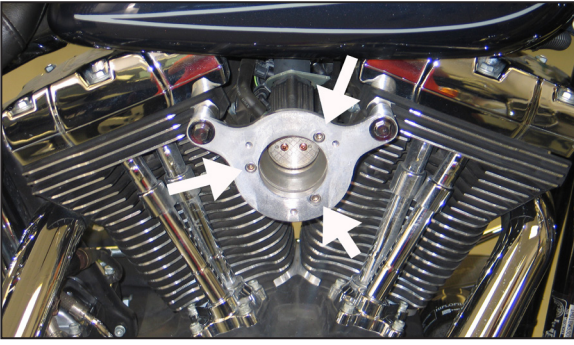

11. Install the provided gasket between the throttle body and back plate and then secure the back plate to the throttle body with the hardware provided. Tighten the crankcase breather bolts.
NOTE: Apply one drop of the provided thread locker onto the provided bolts.

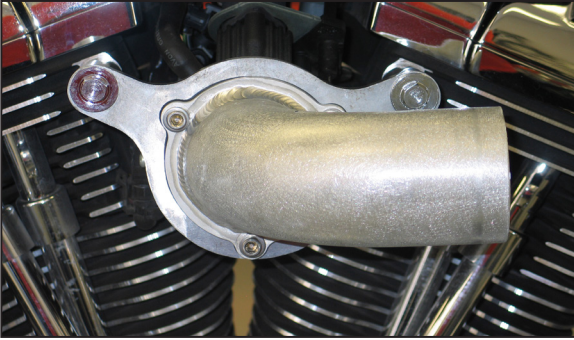

12. Install the K&N® intake tube with the gasket and secure with the provided hardware.
NOTE: Apply one drop of the provided thread locker onto the provided bolts.

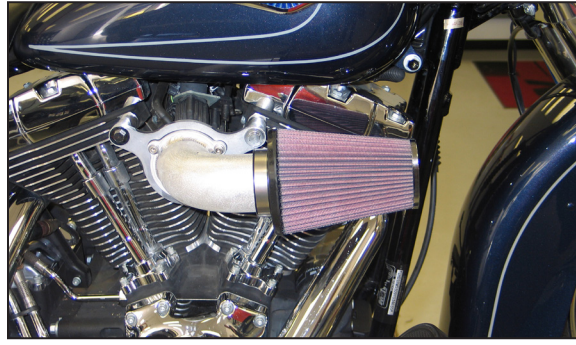

13. Install the K&N® air filter onto the intake tube and secure with the provided hose clamp. A black hose clamp is being supplied with kit. This clamp is intended to clamp the filter to the intake tube.

14. Reconnect the vehicle's negative battery cable. Double check to make sure everything is tight and properly positioned before starting the vehicle.

15. The C.A.R.B. exemption sticker, (attached), must be visible, so the emissions inspector can see it when the vehicle is required to be tested for emissions. California requires testing every two years, other states may vary.

16. It will be necessary for all K&N® high flow intake systems to be checked periodically for realignment, clearance and tightening of all connections. Failure to follow the above instructions or proper maintenance may void warranty.

ROAD TESTING:

1. Start the engine with the transmission in neutral or park. Listen for air leaks or odd noises. For air leaks secure hoses and connections. For odd noises, find cause and repair before proceeding. This kit will function identically to the factory system except for being louder and much more responsive.

2. Test drive the vehicle. Listen for odd noises or rattles and fix as necessary.

3. If road test is fine, you can now enjoy the added power and performance from your kit.

4. K&N Engineering, Inc., suggests checking the air filter element periodically for excessive dirt build-up. When the element becomes covered in dirt (or once a year), service it according to the instructions on the Recharger® service kit, part number 99-5050 or 99-5000.

INTAKE SYSTEMS FOR VEHICLES LISTED ARE 50 STATE LEGAL. SEE KNFILTERS.COM FOR CARB STATUS ON EACH PART FOR A SPECIFIC VEHICLE.