



INTAKE SYSTEMS FOR VEHICLES LISTED ARE 50 STATE LEGAL. SEE KNFILTERS.COM FOR CARB STATUS ON EACH PART FOR A SPECIFIC VEHICLE.

INSTALLATION INSTRUCTIONS

77-2570KTK

FORD

1997-14 E-150/250

1997-16 E-350

2000-16 E-450

V8-5.4L

1997-16 E-350

1997-16 E-450

2002-03 E-550

V10-6.8L

NOTE: This kit was not designed to fit vehicles with a body lift.

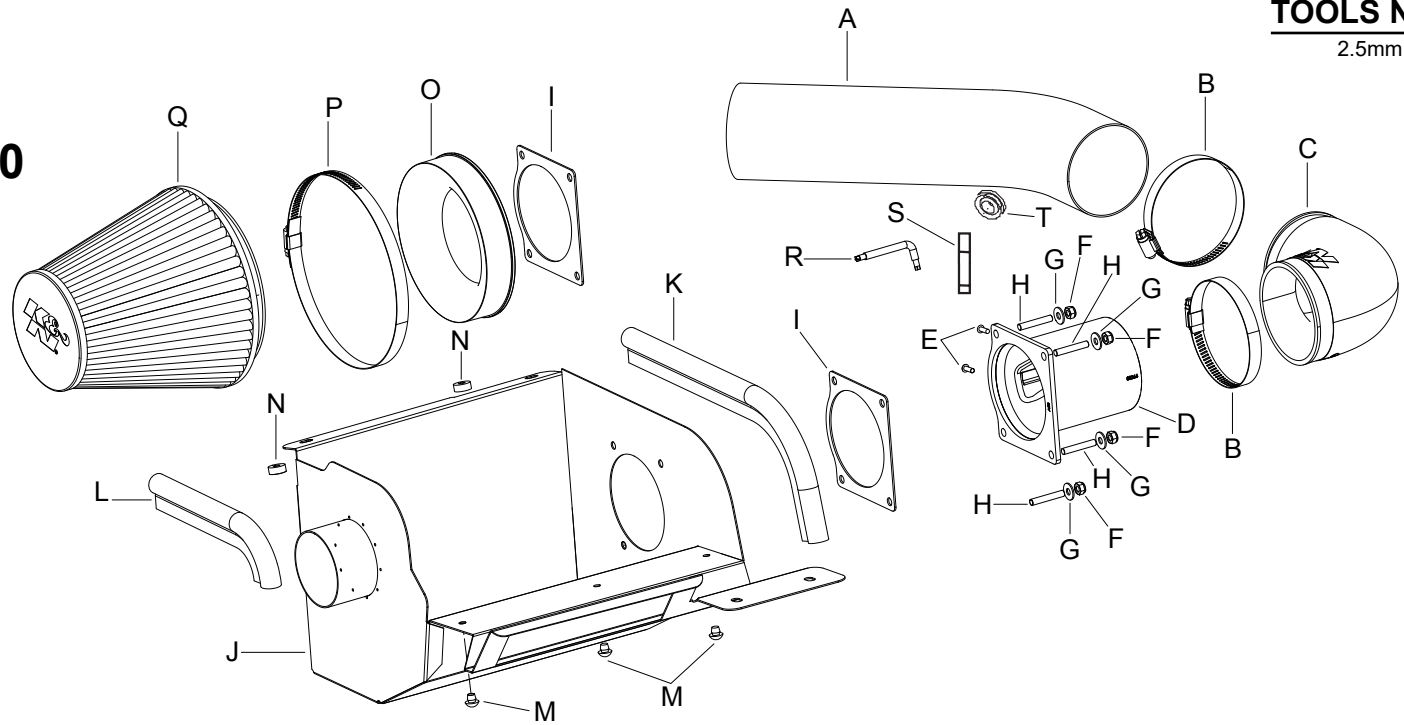

TOOLS NEEDED:

- 2.5mm Allen Wrench
- 10mm Socket
- 8mm Socket
- 7mm Socket
- Extension
- Ratchet

PARTS LIST:

Description	Qty.	Part #	Description	Qty.	Part #	Description	Qty.	Part #
A INTAKE TUBE	1	27186KTK	H STUD; 6MM-1.00 X 35MM L, SS	4	08220	O ADAPTER; FB/PC #250	1	08785A
B HOSE CLAMP #56	2	08620	I GASKET; 1/16" NEOPRENE	2	09984	P HOSE CLAMP #104	1	08697
C HOSE; 3-1/2"ID, ANGLES	1	084088	J HEAT SHIELD	1	07639	Q AIR FILTER	1	RU-5046
D ADAPTER; MAS	1	08266KTK	K EDGE TRIM (14")	1	102475	R WRENCH; TORX T20	1	69801
E SCREW; M4- .7 X 12, BTTN.	2	07726	L EDGE TRIM (9")	1	102465	S THREAD LOCKER	1	482
F NUT; 6MM NYLOCK, HEX	4	07553	M PLUG, RUBBER	3	08162	T GROMMET, 7/16" ID	1	08092
G WASHER; 6MM FLAT, SS	4	08269	N SPACER: .625"ODX.250"IDX.250"	2	06555			

If you need any assistance please call 1-800-858-3333 to speak with a representative in our Customer Service Center before returning the product.

NOTE: FAILURE TO FOLLOW INSTALLATION INSTRUCTIONS AND NOT USING THE PROVIDED HARDWARE MAY DAMAGE THE INTAKE TUBE, THROTTLE BODY AND ENGINE.

TO START:

1. Turn off the ignition and disconnect the negative battery cable.
NOTE: Disconnecting the negative battery cable erases pre-programmed electronic memories. Write down all memory settings before disconnecting the negative battery cable. Some radios will require an anti-theft code to be entered after the battery is reconnected. The anti-theft code is typically supplied with your owner's manual. In the event your vehicles' anti-theft code cannot be recovered, contact an authorized dealership to obtain your vehicles anti-theft code.



2. Unhook the fresh air intake scoop from the radiator core support and then rotate it back to unlock from the air filter assembly. Then remove it from the vehicle.

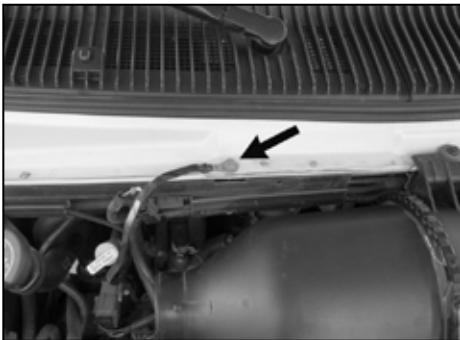

3. Remove the two bolts that secure the air filter assembly to the cowl.
NOTE: One bolt secures a ground strap that will be reinstalled in a later step. These two bolts will be reused.

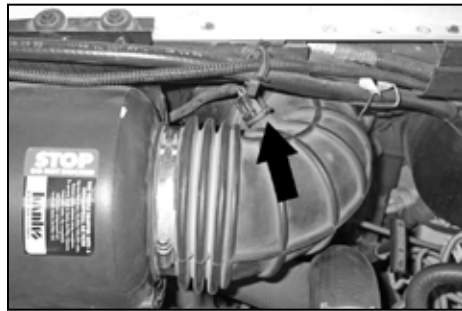

3a. On vehicles equipped with an external air temperature sensor; disconnect the temperature sensor electrical connection.

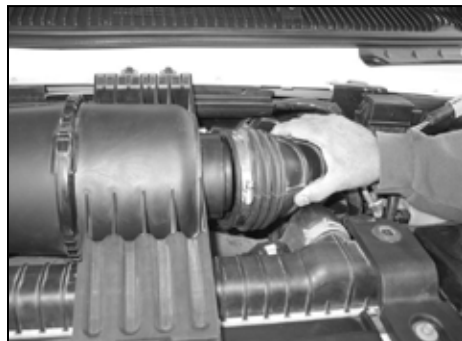

4. Loosen the hose clamp that secures the intake tube to the air filter housing and then disconnect the intake tube from the air filter.



5. Remove the two bolts that secure the air filter housing to the radiator core support.
NOTE: These two bolts will be reused.
NOTE: Some models may come equipped with a plastic cowl cover that conceals the air box mounting bolts. It will be necessary to remove the cover mounting screws and then remove the cover for access the bolts and modifications to the cover.



6. Lift up the air filter housing and unhook the mass air sensor secondary connector from the housing. Then disconnect the mass air sensor secondary connection and remove the filter assembly from the vehicle.

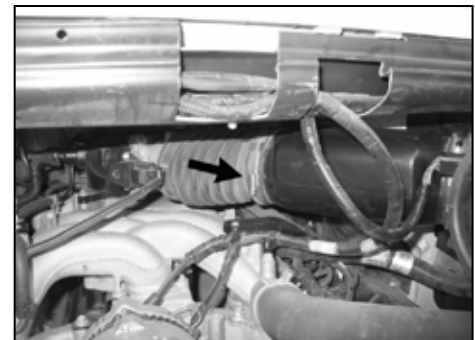

7. Loosen the hose clamp that secures the stock intake tube to the bellows at the throttle body.



8. Remove the intake tube from the vehicle.
NOTE: K&N Engineering, Inc., recommends that customers do not discard factory air intake.

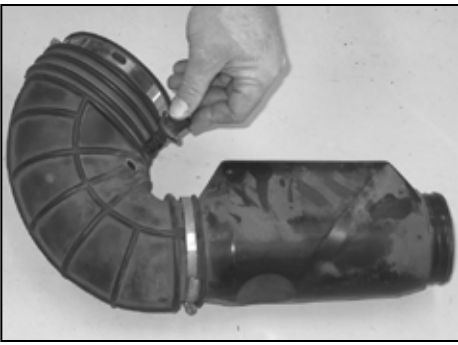

8a. On vehicles equipped with an external air temperature sensor; remove the air temperature sensor from the stock intake tube.
NOTE: The air temperature sensor is fragile; take care when removing.



9. Unlatch the clam shell connector and separate the air filter assembly as shown.

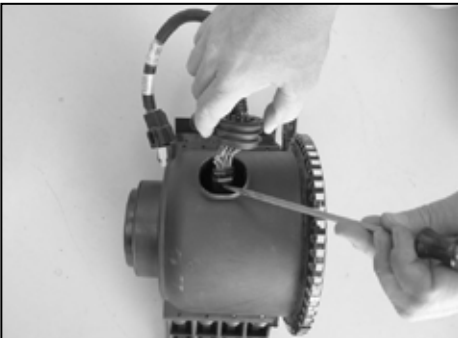

10. Pull back the rubber plug to gain access to the primary mass air sensor connection. Using a small screw driver, release the locking tab and disconnect the mass air sensor electrical connection.



11. Use a screw driver to open the mass air sensor housing and remove the mass air sensor from the housing.

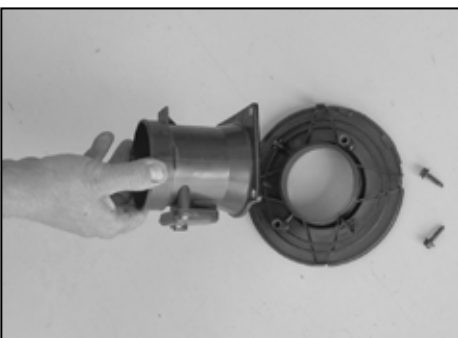

12. On 2005 and earlier vehicles, remove the two bolts that secure the mass air sensor to the mounting plate and then remove the sensor as shown.



13. On 2006 models, remove the two screws that secure the mass air sensor to the housing and then remove the sensor from the housing as shown.

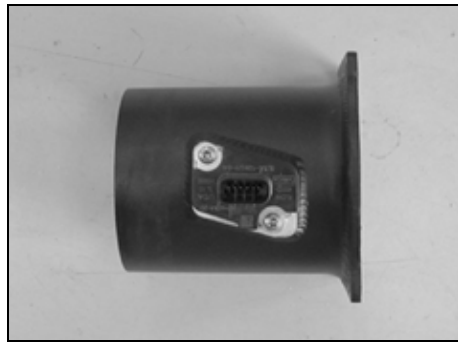

14. On 2006 models, install the mass air sensor removed in step #13 into the mass air sensor housing with the supplied hardware as shown.

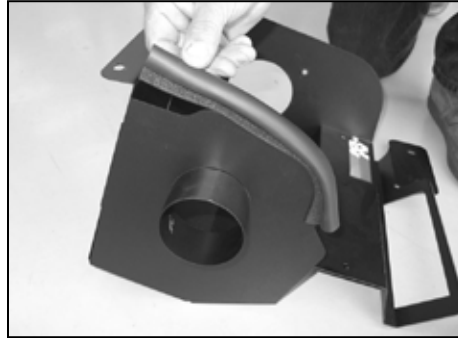

15. Install the short edge trim to the heat shield as shown. Some trimming of the edge trim may be necessary.

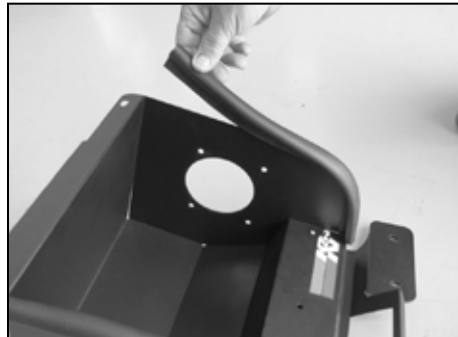

16. Install the long edge trim to the heat shield as shown. Some trimming of the edge trim may be necessary.

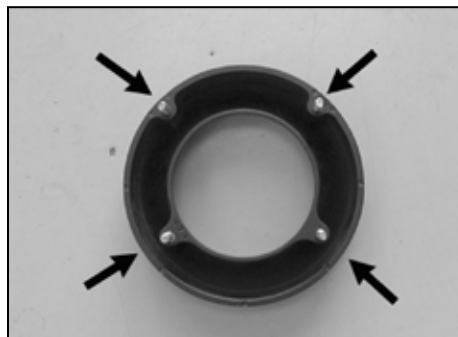

17. Install the four supplied m6 studs into the filter adapter as shown.
NOTE: Be sure to apply the supplied thread locker to the threads of the studs.



18. Install the mass air gasket to the filter adapter as shown.



19. Install the filter adapter into the heat shield as shown.



20. Install the remaining mass air sensor gasket onto the studs of the filter adapter protruding through the heat shield.



21. Install the mass air sensor assembly onto the studs and secure with the provided nuts and washers.



22. Install the three supplied rubber bumpers into the three holes in the heat shield from the bottom up.

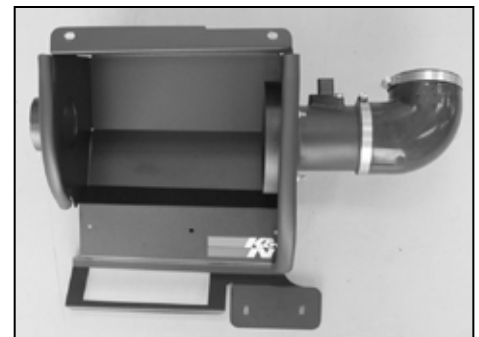

23. Install the silicone hose (084088) onto the mass air sensor housing and secure with the provided hose clamp.



24. Install the K&N[®] air filter onto the filter adapter and secure with the provided hose clamp.



25. Reconnect the mass air sensor primary connector as shown.

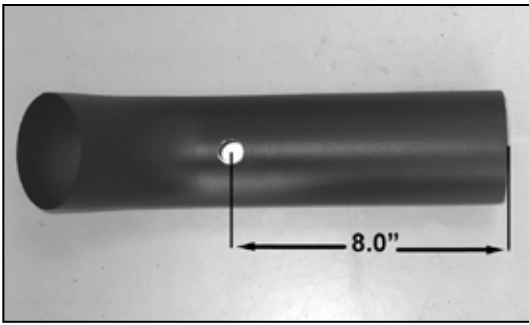

25a. On vehicles equipped with an external temperature sensor; measure and mark the tube 8.0" (from the straight end of the tube, on the inside radius of the bend). Then, drill a 5/8" ID hole in the tube as shown.

NOTE: Ensure all of the burrs and aluminum shavings are removed from the tube before proceeding.

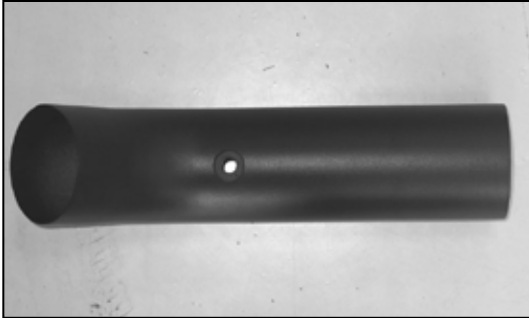

25b. Install the provided grommet into the hole drilled into the intake tube (during the previous step) as shown. Then, install the air temperature sensor into the grommet.

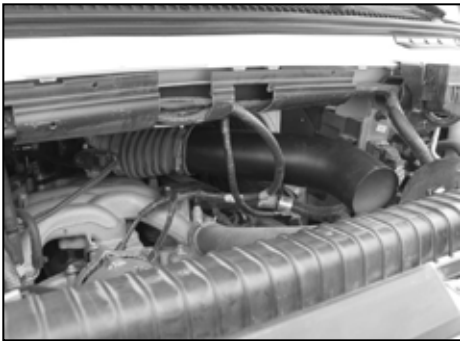

26. Install the K&N® intake tube into the bellows at the throttle body and secure with the factory hose clamp.

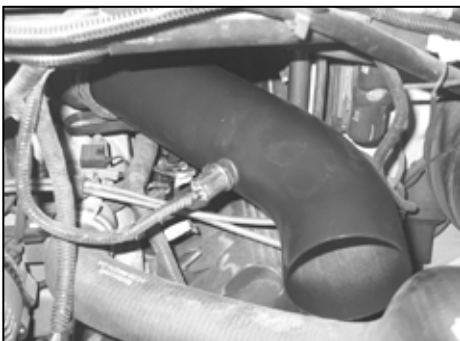

26a. On vehicles equipped with an external air temperature sensor; re-connect the air temperature sensor electrical connection as shown.

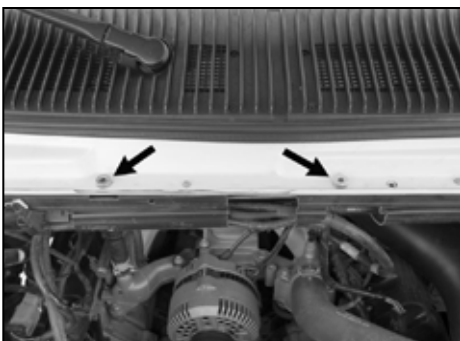

27. Place the two supplied spacers onto the cowl assembly at the air box mounting location as shown.

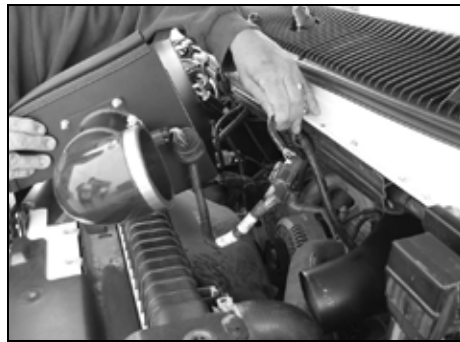

28. Set the filter assembly on top of the radiator assembly, reconnect the mass air sensor secondary connection and then set the filter assembly into position on the cowl and radiator core support.

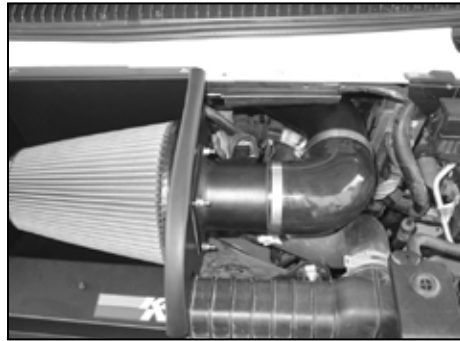

29. Insert the K&N® intake tube into the silicone hose at the throttle body and secure with the provided hose clamp.



30. Using the factory bolts removed in step #3, secure the heat shield to the cowl.

NOTE: Be sure the spacers are in position and to attach the ground strap.

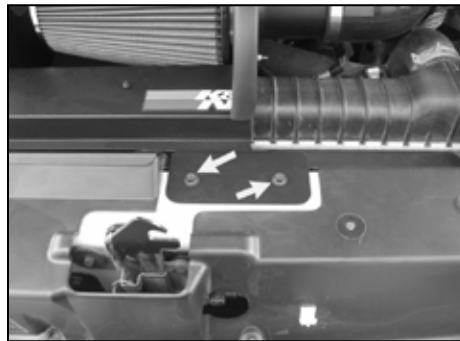

31. Using the factory bolts removed in step #5 secure the heat shield to the radiator core support.

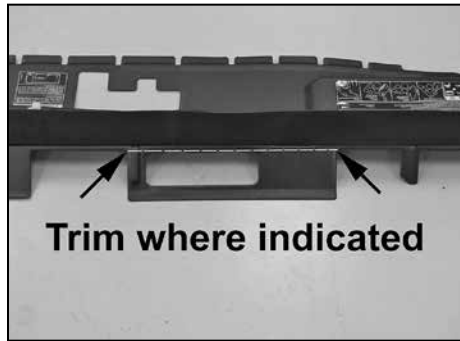

31a. On vehicles that the cowl cover conceals the air box mounting bolts, trim the cover as indicated by the dashed line so that the cover will sit flat onto the cowl.

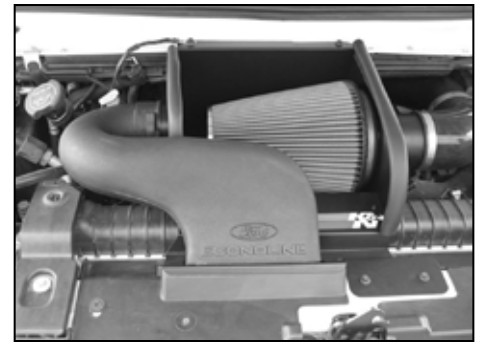

32. Install the factory fresh air scoop onto the heat shield and then latch it into the cut out and factory opening as shown.

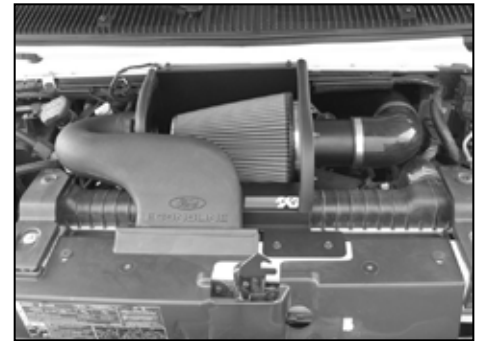

33. Reconnect the vehicle's negative battery cable. Double check to make sure everything is tight and properly positioned before starting the vehicle.

34. The C.A.R.B. exemption sticker, (attached), must be visible under the hood so that an emissions inspector can see it when the vehicle is required to be tested for emissions. California requires testing every two years, other states may vary.

35. It will be necessary for all K&N® high flow intake systems to be checked periodically for realignment, clearance and tightening of all connections. Failure to follow the above instructions or proper maintenance may void warranty.

ROAD TESTING:

1. Start the engine with the transmission in neutral or park, and the parking brake engaged. Listen for air leaks or odd noises. For air leaks secure hoses and connections. For odd noises, find cause and repair before proceeding. This kit will function identically to the factory system except for being louder and much more responsive.

2. Test drive the vehicle. Listen for odd noises or rattles and fix as necessary.

3. If road test is fine, you can now enjoy the added power and performance from your kit.

4. K&N Engineering, Inc., requires cleaning the intake system's air filter element every 100,000 miles. When used in dusty or off-road environments, our filters will require cleaning more often. We recommend that you visually inspect your filter once every 25,000 miles to determine if the screen is still visible. When the screen is no longer visible some place on the filter element, it is time to clean it. To clean and re-oil, purchase our filter Recharger® service kit, part number 99-5050 or 99-5000 and follow the easy instructions.

INTAKE SYSTEMS FOR VEHICLES LISTED ARE 50 STATE LEGAL. SEE KNFILTERS.COM FOR CARB STATUS ON EACH PART FOR A SPECIFIC VEHICLE.